

2014



BUILDERS HARDWARE



Rolling Ladder



Carpet Rods for Stairways



Hardware (Receptacle Covers)



DOOR HARDWARE

Levers

Hooks

Dead Bolts

Knobs

Hinges

Cremona Bolts

Door Stopper

Latchsets

Indoor Return Air Grilles

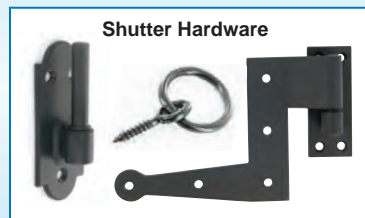

Shutter Hardware

Heat Registers



Rolling Ladder Hardware Components

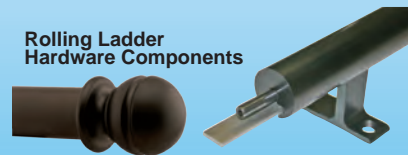

CARPET RODS FOR STAIRWAYS	888	Hooks	INDOOR RETURN AIR GRILLES	891
DOOR HARDWARE		Coat & Hat Hooks.....	OMNIA.....	871-877
<i>Cremona Bolts</i>		Fork Hook.....	ROLLING LADDER	870
Omnia.....	875	Latch Hooks.....	ROLLING LADDER HARDWARE	
<i>Deadbolts</i>		Omnia.....	<i>Hardware Components</i>	
Grandeur by Nostalgic.....	879, 880, 881	Rotating Specialty Hook.....	90° Inside Corner.....	868
Nostalgic Warehouse.....	882	Sugatsune.....	End Stops.....	868
<i>Door Closer</i>		Swing Specialty Hook.....	Rung Support.....	868-869
Sugatsune.....	887	Knob Set	Splice Kits.....	868
<i>Door Knockers</i>		Glass Crystal Replacement Knob Set.....	Support Brackets.....	868
Omnia.....	877	Knobs	Track.....	868
<i>Door Stopper</i>		Grandeur by Nostalgic.....	Wood Components	
Sugatsune.....	887	Nostalgic Warehouse.....	Ladder.....	869
<i>Door Stops</i>		Omnia (Prodigy).....	Wooden Hand Rails (Steam Bent).....	869
Drop Down Door Holder.....	886	Latchsets	ROLLING LADDER HARDWARE KIT	866-867
Heavy Duty Door Floor Stop.....	886	Omnia.....	SHUTTER HARDWARE	
High Profile Solid Brass.....	886	Levers	Lag Bolt.....	892
Low Profile Solid Brass.....	886	Grandeur by Nostalgic.....	Long Arm Extension.....	892
Omnia.....	877	Mortise Door Bolt.....	Pintles.....	893
<i>Doorbells (Twist)</i>		Pocket Door Hardware.....	Shutter Bolts.....	893
Nostalgic Warehouse.....	883	Roller Ball Catches.....	Shutter Dogs.....	892
<i>Exterior Handlesets w/ Interior Trim</i>		Roses	Shutter Hinges.....	892
Grandeur by Nostalgic.....	879, 881	Omnia (Prodigy).....	Shutter Rings.....	893
<i>Handles</i>		Storm Door Latch.....	Surface Plate.....	892
Omnia (Prodigy).....	871	Surface Bolts.....	TOILET PARTITION HARDWARE	
<i>Hinges</i>		HARDWARE	Additional Stall Kits.....	894
Double Action Spring.....	885	<i>Receptacle Covers</i>	Complete Stall Kits.....	894
Omnia.....	877	Omnia.....		
Steel.....	885	<i>Switchplate Covers</i>		
Hooks		Omnia.....		
Butterfly Specialty Hook.....	889	HEAT REGISTERS		890

SEE PAGES 1007-1023 FOR A - Z INDEX

ROLLING LADDER HARDWARE KIT



Hardware Components Only

Material: Powder Coated Steel

LIBRARIES • WINE CELLARS • KITCHENS • STORAGE AREAS

We have made creating your own rolling ladder system simple and convenient. We've assembled a kit which provides all the hardware needed to build an **8 foot ladder** (9' & 10' also available). From the **whisper quiet top roller and non-marring wheels**, our hardware kits offer unsurpassed quality and value.

**Readily Available
From Stock**



Finishes Available:



2 ROLLING LADDER KITS AVAILABLE

Ultra-Quiet Bar Rollers



ROLLING HOOK HARDWARE KIT:

This application is used for multiple sections of track. The rolling **hook** allows you to remove the ladder from one track and move to another track easily and quickly.

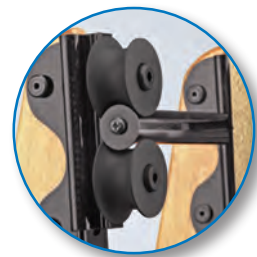

ROLLING GLIDE HARDWARE KIT:

This application is used for one continuous run of track. The rolling **glides** are locked onto track once installed.

RAIL HEIGHT AND DISTANCE for 8', 9', 10' standard ladders

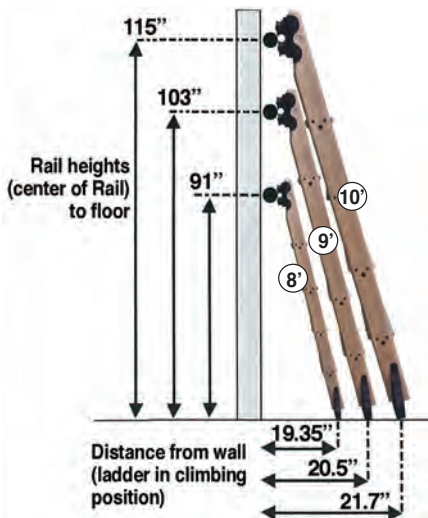

Non-Marring Wheel Large (4" Dia.)



Roller With Brake

Brake is applied upon stepping on the ladder and has an adjustable spring to accommodate ladder weight.





Hardware Components Only

Material: Powder Coated Steel

Order your Rolling Ladder In A Few Easy Steps:

Step 1

Choose Your Kit

- Rolling **Hook** Hardware Kit for multiple sections of track
- Rolling **Glide** Hardware Kit for one continuous run of track.

Step 2

How Many Feet of Track Do You Need?

Available in 4' & 8' lengths & 90° curves

Step 3

How Many Support Brackets?

You'll need one every 32"
(Be sure to order correctly for Rolling **Hook** Hardware Kit or Rolling **Glide** Hardware Kit)

Step 4

How Many Splice Kits Will You Need?

You'll need one for each length of track you're joining

Step 5

How Many Pair of End Stops?

You'll need 1 pr for each run of track.

Step 6

Choose Your Ladder

Maple, Oak or Cherry?
Don't forget 1 or 2 additional rung supports if you are ordering a 9' or 10' ladder

See Page 869 For Ladders

Step 1

Build Your Own Rolling Ladder Kit



ROLLING HOOK HARDWARE KIT:

Traditional Wheels

	PART #	COLOR
NO BRAKE	RHK-HOOK-10	Matte Black
	RHK-HOOK-20	Oil Rubbed Bronze
	RHK-HOOK-30	Hammered Antique Brass
	RHK-HOOK-40	Satin Nickel
WITH BRAKE	RHK-HOOK-10BRK	Matte Black
	RHK-HOOK-20BRK	Oil Rubbed Bronze
	RHK-HOOK-30BRK	Hammered Antique Brass
	RHK-HOOK-40BRK	Satin Nickel

Contemporary Wheels

	PART #	COLOR
NO BRAKE	RHK-HOOK-10-CON	Matte Black
	RHK-HOOK-20-CON	Oil Rubbed Bronze
	RHK-HOOK-30-CON	Hammered Antique Brass
	RHK-HOOK-40-CON	Satin Nickel

Kit Includes:

- Lower ladder wheels (2)
- Hook top guides (2)
- Rung support rods (7)
- All fasteners needed to make an 8 ft. ladder



Traditional Wheels

Wheels

ROLLING GLIDE HARDWARE KIT:



Traditional Wheels

	PART #	COLOR
NO BRAKE	RHK-10	Matte Black
	RHK-20	Oil Rubbed Bronze
	RHK-30	Hammered Antique Brass
	RHK-40	Satin Nickel
WITH BRAKE	RHK-10-BRK	Matte Black
	RHK-20-BRK	Oil Rubbed Bronze
	RHK-30-BRK	Hammered Antique Brass
	RHK-40-BRK	Satin Nickel

Contemporary Wheels

	PART #	COLOR
NO BRAKE	RHK-10-CON	Matte Black
	RHK-20-CON	Oil Rubbed Bronze
	RHK-30-CON	Hammered Antique Brass
	RHK-40-CON	Satin Nickel

Kit Includes:

- Lower ladder wheels (2)
- Upper rolling top guides (2)
- Rung support rods (7)
- All fasteners needed to make an 8 ft. ladder

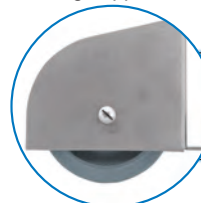

Contemporary Wheels

PLEASE NOTE: Outside width of ladder should be built 16" wide to accept the ladder step support rods. Track can be cut to size. The track requires support brackets every 32".

(Components sold separately, see page 868)
(See page 869 for Unassembled Stain Grade Ladders)

ROLLING LADDER HARDWARE



Hardware Components Only

Material: Powder Coated Steel

Step 2

Track (4 FT. or 8 FT.)



• 1" diameter x 4 ft. or 8 ft. solid aluminum track

PART #	SIZE	COLOR
RLH-T4-BK	4 FT.	Matte Black
RLH-T4-ORB		Oil Rubbed Bronze
RLH-T4-AB		Hammered Antique Brass
RLH-T4-SN		Satin Nickel
RLH-T8-BK	8 FT.	Matte Black
RLH-T8-ORB		Oil Rubbed Bronze
RLH-T8-AB		Hammered Antique Brass
RLH-T8-SN		Satin Nickel

Step 3

Support Brackets

Roll Glide Type

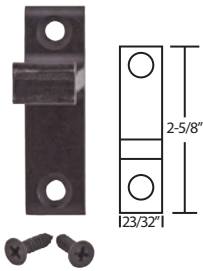

- Support brackets (screws included) recommended maximum spacing 32"

PART #	COLOR
RLH-SUPPORT-BK	Matte Black
RLH-SUPPORT-ORB	Oil Rubbed Bronze
RLH-SUPPORT-AB	Hammered Antique Brass
RLH-SUPPORT-SN	Satin Nickel

Hook Type

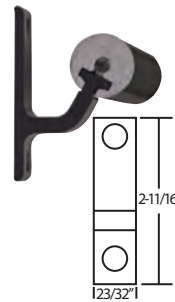

PART #	COLOR
RLH-HK-SUPPORT-BK	Matte Black
RLH-HK-SUPPORT-ORB	Oil Rubbed Bronze
RLH-HK-SUPPORT-AB	Hammered Antique Brass
RLH-HK-SUPPORT-SN	Satin Nickel

Step 4

Splice Kits

- Steel support dowel included for joining multiple tracks

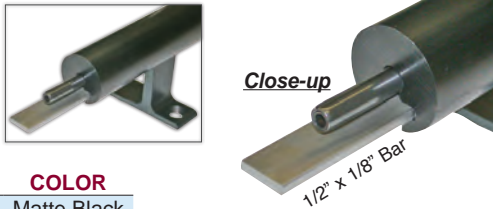

PART #	COLOR
RLH-DOWEL	Matte Black

Rung Support

Extra support for ladders over 8' long



Material: Steel • Finish: Matte Black

RLH-RSK

NUMBER OF RUNG SUPPORTS REQUIRED

LADDER		
8'	9'	10'
7 ea.	8 ea.	9 ea.

Step 5

End Stops

Flat End Stop



Ball End Stop



Sold In Pairs

Flat End Stops

PART #	COLOR
RLH-ESTOP-BK	Matte Black
RLH-ESTOP-ORB	Oil Rubbed Bronze
RLH-ESTOP-AB	Hammered Antique Brass
RLH-ESTOP-SN	Satin Nickel

Ball End Stops

PART #	COLOR
RLH-BALLSTOP-BK	Matte Black
RLH-BALLSTOP-ORB	Oil Rubbed Bronze
RLH-BALLSTOP-AB	Hammered Antique Brass
RLH-BALLSTOP-SN	Satin Nickel

90° Inside Corner

30° Radius • 5 Ft. Length

For use with rolling glide hardware kit only (not hook kit)

PART #	COLOR
RLH-IC-BK	Matte Black
RLH-IC-ORB	Oil Rubbed Bronze
RLH-IC-AB	Hammered Antique Brass
RLH-IC-SN	Satin Nickel

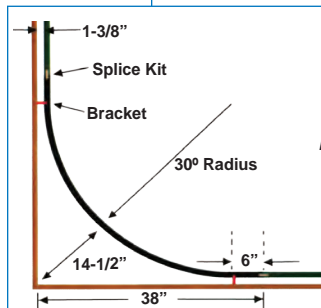

UNASSEMBLED STAINGRADE LADDERS



Wood Components Only

Staingrade, unfinished & sanded to 120 Grit

- 8 ft. • 9 ft. • 10 ft. unassembled ladder kits
(Wood Components - Includes: side rails, steps & Top "Turned" Rung)
- Available in Oak, Maple & Cherry
- Pre-drilled holes for fasteners
- The sides dadoed for steps

Step 6

Ladder

PART #	DESCRIPTION
LDR-8-*	8' unassembled Library Ladder
LDR-9-*	9' unassembled Library Ladder
LDR-10-*	10' unassembled Library Ladder

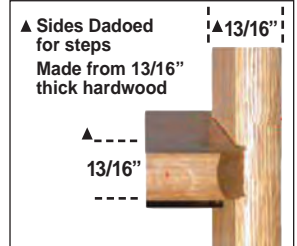
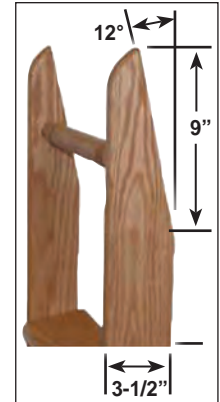
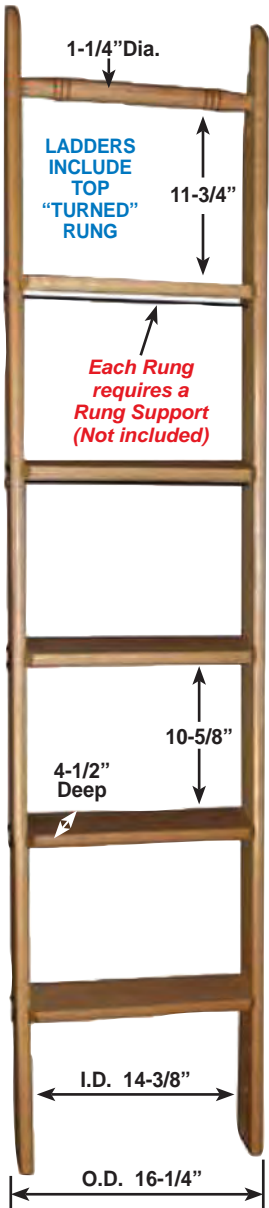

Steam Bent Wooden Hand Rails

PART #	COLOR
RLH-HR-CH	Cherry
RLH-HR-MP	Maple
RLH-HR-RO	Red Oak

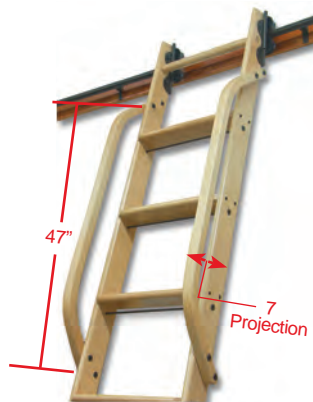

Rung Supports

EACH RUNG REQUIRES A RUNG SUPPORT

Material: Steel • Finish: Matte Black



RLH-RSK

Spacing between rungs is 10-5/8" (Top Rung is 11-3/4")

NUMBER OF RUNG SUPPORTS REQUIRED

LADDER	8'	9'	10'
	7 ea.	8 ea.	9 ea.

See Page 868 for Rolling Ladder Hardware



Custom, made to order sizes complete with hardware:

The Rolling Ladder is a beautiful addition to any home or business: it endures the rigors of industry yet has the grace and beauty of fine furniture. The standard wood species for the ladder is Red Oak. Steps are screwed to rails (not nailed) and rods are placed under each step, for greater strength. The ladder stores flat against your wall or bookcase when not in use.

- LIBRARIES
- LOFTS
- KITCHENS
- WINE CELLARS
- STOCK ROOMS

ADDITIONAL WOOD SPECIES:

- Mahogany
- Maple
- Birch
- Ash
- Cherry
- Red Oak (Standard)
- Beech
- Hickory
- Teak
- Walnut
- White Oak

Note: All come unfinished unless specified otherwise

FIXTURE FINISHES



Note: The finish that you choose for your track is the finish that will be applied to all of the fixtures on the ladder.

The top slide feature available in either roll type or hook slide permits the rolling ladder to be pulled out for use or pushed back against shelves to conserve space.

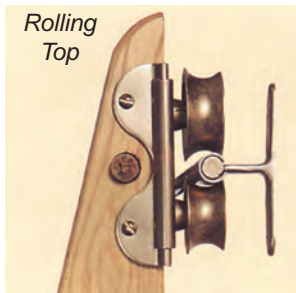

The roll type top fixture is for a ladder permanently attached to the track.



The hook/slide top fixture is used when a ladder needs to be removed from one section of track to another.

The ladder rolls easily with bottom fixtures shown.

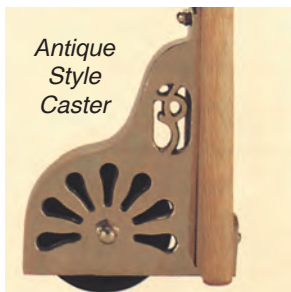

Lead time is 5-7 weeks.

NOW LADDER HARDWARE CAN BE PURCHASED SEPARATELY

See page 868



LATCHSETS

Prodigy by OMNIA

New

Forging Affordable Elegance

- Solid Brass latchsets with tough, non-rusting materials used throughout
- Seven of the most popular interior latchsets to complement any decor
- Available in seven finishes
- Choice of four roses (back plates) allows for customizing the perfect look

*Please Specify Function When Ordering:

PA - Passage SD - Single Dummy**
 PR - Privacy PD - Pair Dummy**
 **Not recommended for commercial use

HANDLES / KNOBS



ROSES

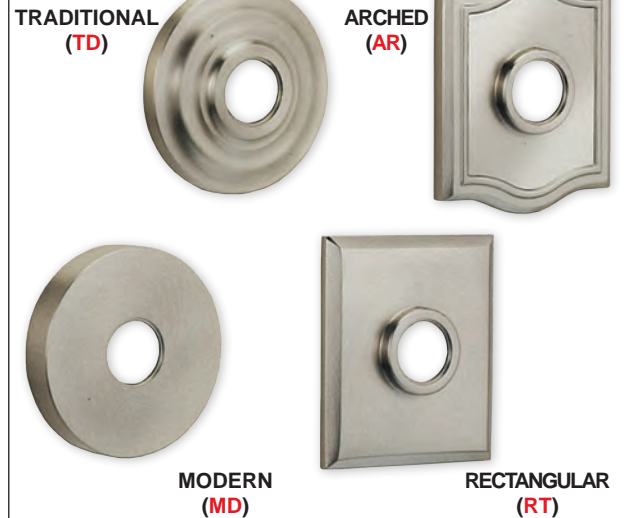

FINISHES

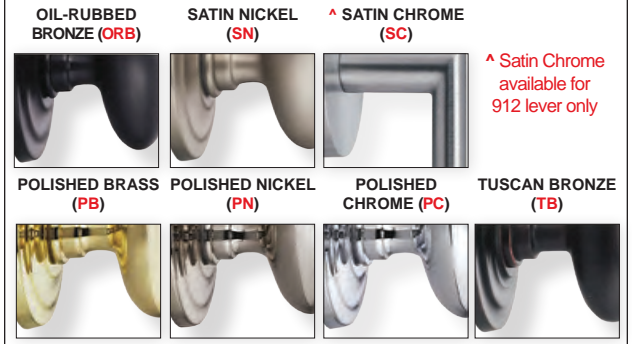

PART

- OH785*
- OH434*
- OH895*
- OH458*
- OH912*
- OH565*
- OH955*

All part #'s are available in:

4 functions- Passage, Privacy, Pair Dummy & Single Dummy

4 Roses- Traditional or Modern Round Roses, Rectangular or Arched Rose

Example of how to order: OH785PB-PA-TD (785 Latchset, Polished Brass Finish, Passage Function with Traditional Rose)

STAINLESS STEEL LATCHSETS



- Solid Stainless Steel
- Supplied with 2-3/8" backset and 1-3/8" door thickness - unless otherwise specified. (2-3/4" backset available, Must specify).
- Will Fit 2-1/8" Bore
- Standard For 1-3/8" Thick Door (Other Sizes Available-Please Inquire)

*Please Specify Function When Ordering:
 PA - Passage SD - Single Dummy**
 PR - Privacy PD - Pair Dummy**
 **Not recommended for commercial use

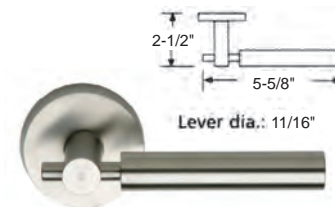
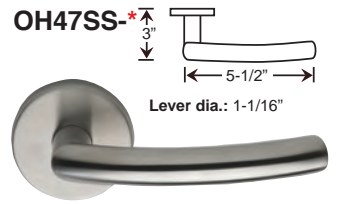
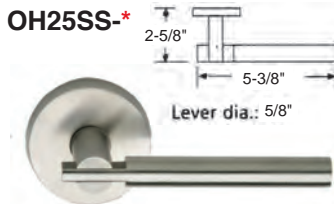
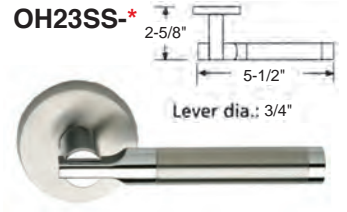
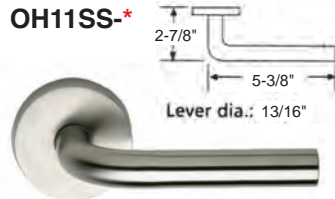

OH33SS-*

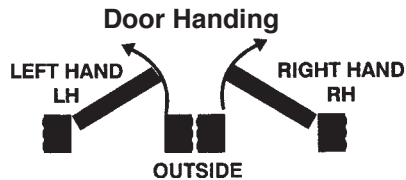

AVAILABLE IN USA ONLY

SOLID BRASS LATCHSETS



- Solid Polished Lacquered Brass
- Supplied with 2-3/8" backset and 1-3/8" door thickness - unless otherwise specified. (2-3/4" backset available, Must specify).
- Will Fit 2-1/8" Bore
- Standard For 1-3/8" Thick Door (Other Sizes Available-Please Inquire)
- CHROME IS PLATED OVER SOLID BRASS

*Please Specify Function When Ordering:
 PA - Passage SD - Single Dummy**
 PR - Privacy PD - Pair Dummy**
 **Not recommended for commercial use

OH55BR-*

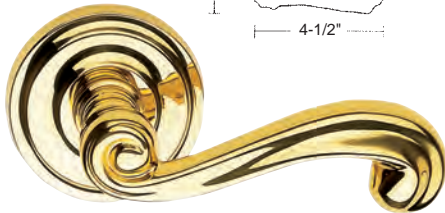

Specify Right or Left Hand

OH42BR-*
OH42CH-*

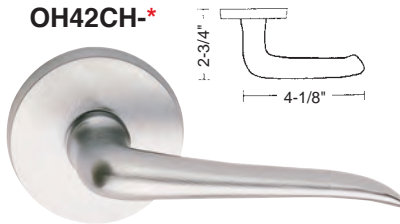

Specify Right or Left Hand

OH441BR-*
OH441CH-*



OH570-*

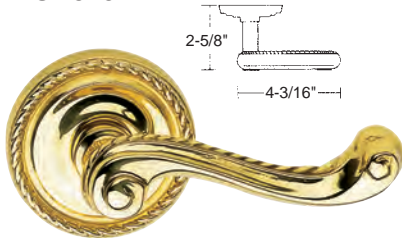

Specify Right or Left Hand

OH368BR-*
OH368CH-*

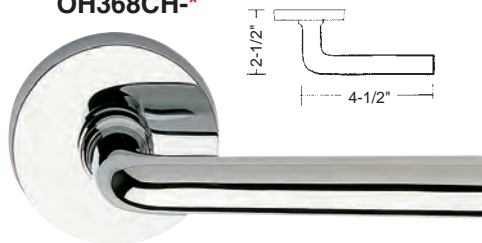

OH430BR-*

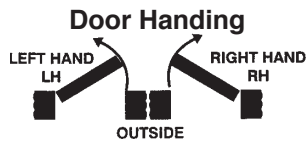

AVAILABLE IN USA ONLY

PART #	FINISH	OTHER FINISHES AVAILABLE (INQUIRE)
OH55BR-*	Brass	Chrome, Max Brass, Shaded Bronze
OH42BR-*	Brass	Satin Chrome, Max Brass
OH42CH-*	Chrome	Satin Chrome, Max Brass
OH441BR-*	Brass	Shaded Bronze
OH441CH-*	Chrome	N/A
OH570BR-*	Brass	Chrome, Shaded Bronze
OH368BR-*	Brass	Satin Chrome
OH368CH-*	Chrome	Satin Chrome
OH430BR-*	Brass	Chrome, Shaded Bronze

SOLID BRASS LATCHSETS

OMNIA

- Solid Polished Lacquered Brass
- Supplied with 2-3/8" backset and 1-3/8" door thickness - unless otherwise specified. (2-3/4" backset available, Must specify).
- Will Fit 2-1/8" Bore
- Standard For 1-3/8" Thick Door (Other Sizes Available-Please Inquire)
- CHROME IS PLATED OVER SOLID BRASS

*Please Specify Function When Ordering:

PA - Passage SD - Single Dummy**

PR - Privacy PD - Pair Dummy**

**Not recommended for commercial use

OH430BR-*

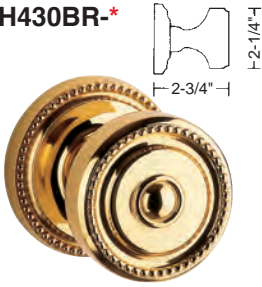

OH415BR-
OH415CH-*



OH36BR-*



OH752BR-*



OH251BR-*



OH572BR-*



OH417BR-*

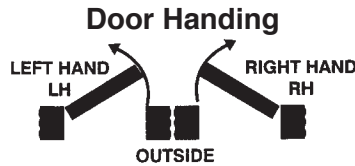

AVAILABLE IN USA ONLY

PART #	FINISH	OTHER FINISHES AVAILABLE (INQUIRE)
OH430BR-*	Brass	Chrome, Shaded Bronze
OH415BR-*	Brass	Satin Chrome
OH415CH-*	Chrome	Satin Chrome
OH36BR-*	Brass	Chrome, Satin Chrome, Oil Rubbed Bronze
OH752BR-*	Brass	Pewter, Chrome, Shaded Bronze, Oil Rubbed Bronze, Satin Nickel
OH251BR-*	N/A	Shaded Bronze, Max Brass
OH572BR-*	N/A	Shaded Bronze
OH417BR-*	N/A	Shaded Bronze



OH2057/CR-BR

Furnished with knob and 7-3/16" x 1-1/2" x 5/8" cremone mechanism, with two rods—one 72" long & one 40" long, four guides (two large and two small), and two strikes (one endpiece strike and one mortise strike).

-  Endpiece Strike
-  Large Guide
-  Small Guide
-  Mortise Strike



OH432/CR-BR

Set includes a knob with 5" x 1-1/2" x 1/2" cremone mechanism, a bottom rod of 40" and a top rod of 72" plus a set of three guides and four strikes. (2 mortise strikes & 2 universal strikes).

-  Mortise Strike
-  Guide or Endpiece
-  Universal Strike



AVAILABLE IN USA ONLY 

SWITCHPLATE/RECEPTACLE COVERS



Modern Style

	PART #	STYLE
A	OH8012/S-	Single
B	OH8012/R-	Receptacle
C	OH8012/D-	Double
D	OH8012/C-	Combination
E	OH8012/T-	Triple
F	OH8023/S-	Single Rocker
G	OH8023/D-	Double Rocker
H	OH8023/T-	Triple Rocker

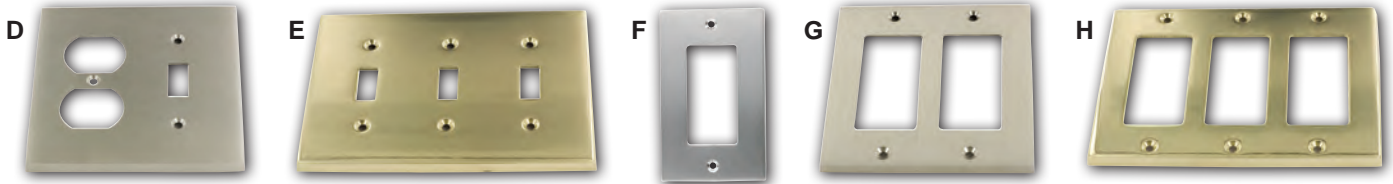
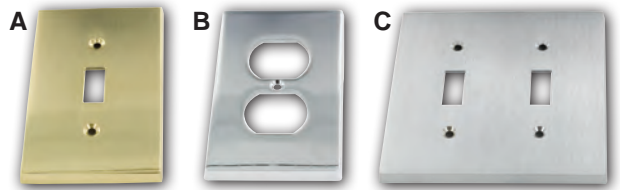

Traditional Style

	PART #	STYLE
I	OH8014/S-	Single
J	OH8014/R-	Receptacle
K	OH8014/D-	Double
L	OH8014/C-	Combination
M	OH8014/T-	Triple
N	OH8024/S-	Single Rocker
O	OH8024/D-	Double Rocker
P	OH8024/T-	Triple Rocker

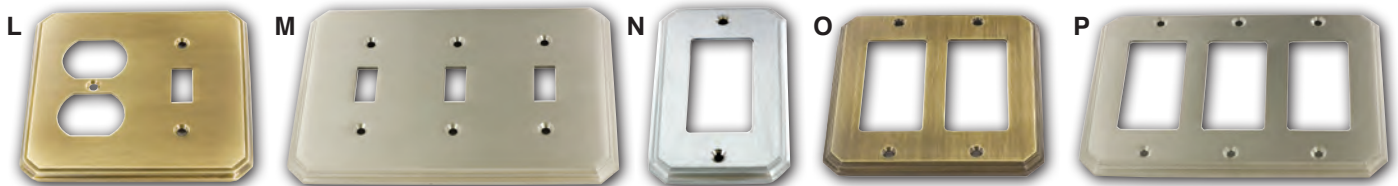
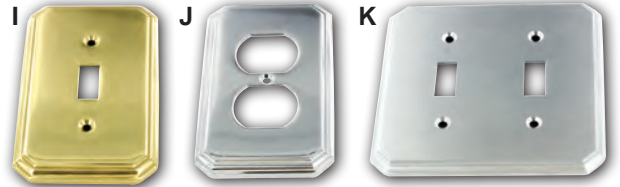

Beaded Style

	PART #	STYLE
Q	OH8004/S-	Single
R	OH8004/R-	Receptacle
S	OH8004/D-	Double
T	OH8004/C-	Combination
U	OH8004/T-	Triple
V	OH8005/S-	Single Rocker
W	OH8005/D-	Double Rocker
X	OH8005/T-	Triple Rocker

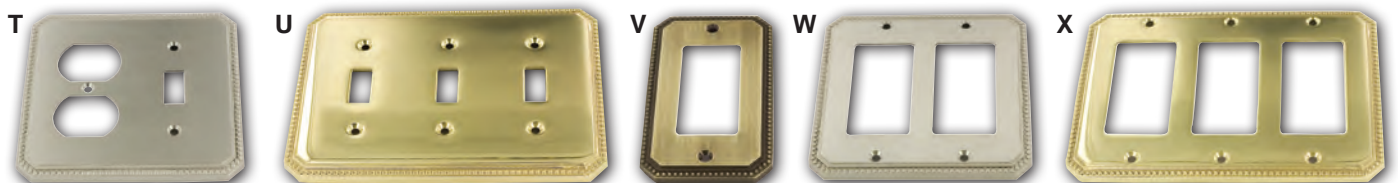
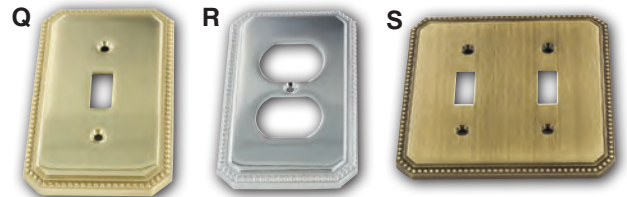

AVAILABLE IN USA ONLY

SOLID BRASS HINGES



• PLAIN BEARING, FULL MORTISE HINGE • SOLID EXTRUDED BRASS

3-1/2" x 3-1/2"

hinges supplied w/button tips as shown

PART #	FINISH
OH985/35BTN-BR	Brass
OH985/35BTN-CH	Chrome
OH985/35BTN-SCH	Satin Chrome
OH985/35BTN-ABR	Antique Brass
OH985/35BTN-MBR	Max Brass



(Each hinge requires 1 pair of finials)

4" x 4"

hinges supplied w/button tips as shown

PART #	FINISH
OH985/4BTN-BR	Brass
OH985/4BTN-CH	Chrome
OH985/4BTN-SCH	Satin Chrome
OH985/4BTN-ABR	Antique Brass
OH985/4BTN-MBR	Max Brass



OPTIONAL FINIALS

(Each hinge is supplied with button tips as shown)

PART #	STYLE	*AVAILABLE FINISHES:
A OH085/STP2-*	Steeple	Brass, Chrome, Satin Chrome, Antique Brass, Max Brass
B OH085/CRN2-*	Crown	
C OH085/BAL2-*	Ball	
D OH085/ACN2-*	Acorn	
E OH085/URN2-*	Urn	



BALL BEARING, FULL MORTISE HINGE SOLID EXTRUDED BRASS

4" x 4"

hinges supplied w/button tips as shown

PART #	FINISH
OH985BB/4BTN-BR	Brass
OH985BB/4BTN-CH	Chrome
OH985BB/4BTN-SCH	Satin Chrome
OH985BB/4BTN-ABR	Antique Brass
OH985BB/4BTN-MBR	Max Brass

SOLID BRASS DOOR STOPS

OH1148

OH1147

OH2001



PART #	FINISH	SIZE
OH1148-BR	Brass	3-3/4" Projection
OH1148-CH	Chrome	3-3/4" Projection
OH1147-BR	Brass	3" Projection
OH1147-CH	Chrome	3" Projection
OH2001-BR	Brass	7-1/6" x 1-1/8" W (2" throw)
OH2001-CH	Chrome	7-1/6" x 1-1/8" W (2" throw)

BRASS DOOR KNOCKERS



OH76/80-BR
6" High



OH700/00-BR
6" High



OH78/90-BR
7" High

SOLID BRASS HOOKS



PART #	FINISH	SIZE
OH208-BR	Brass	5-3/16" x 2-5/8" Projection
OH208-CH	Chrome	5-3/16" x 2-5/8" Projection
OH212-BR	Brass	1-5/8" x -5/16" Projection
OH205-BR	Brass	1-1/2" x 1-5/8" Projection
OH210-BR	Brass	3" x 3" Projection
OH215-BR	Brass	3-1/2" x 1-3/4" Base/ 4-5/16" Projection
OH213-BR	Brass	1-1/2" x 3/4" Projection

AVAILABLE IN USA ONLY

GRANDE
VICTORIAN
DEADBOLT



FIFTH AVENUE
INTERIOR
FONTAINBLEAU
KNOB



*Discover the differences
between the Nostalgic
Warehouse products and
the "New" Grandeur Line*

	<i>Grandeur</i> By NOSTALGIC WAREHOUSE.	By NOSTALGIC WAREHOUSE.
Vintage Designs	Yes	Yes
Forged Brass Trim	Yes, solid knobs & levers	Yes, hollow knobs, no levers
Ornate Designs	Yes, with exquisite detail	Yes
Lead Crystal Knobs	Yes, 24% lead content	Yes, 9% lead content
Mix & Match	Yes, knob attached to plate at factory	Yes, knob & plates are separately installed pieces
New construction appropriate	Only for modern prepped pre-drilled doors	Yes, works with both modern or antique doors
Restoration appropriate	Only for modern prepped pre-drilled doors	Yes, works with both modern or antique doors
Quality Tubular Latch	Yes, easy handing	Yes, easy handing
Interior Mortise Case Compatible	No	Yes, Interior Mortise Case Available
Lifetime warranties	Yes, on both Mechanical & Finish issues	Yes, on both Mechanical & Finish issues
Breadth of finishes	Yes, six finishes, plus PVD lifetime finish	Yes, six finishes



NEWPORT
EXTERIOR
S-GRIP



WINDSOR
EXTERIOR
F-GRIP



PARTHENON
INTERIOR
BELLAGIO
LEVER



GEORGETOWN
INTERIOR
PORTOFINO LEVER

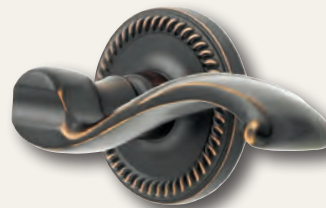

NEWPORT
INTERIOR
PORTOFINO LEVER



GRANDE
VICTORIAN
INTERIOR
KNOB

THE GRANDE VICTORIAN COLLECTION

SINGLE CYLINDER DEADBOLTS



SATIN NICKEL = SN



TIMELESS BRONZE = TB



ANTIQUE PEWTER = AP



VINTAGE BRASS = VB



LIFETIME BRASS = LB (EXTERIOR FINISH)

PART #	FINISH
GD-GVCSCD-SN	Satin Nickel
GD-GVCSCD-TB	Timeless Bronze
GD-GVCSCD-AP	Antique Pewter
GD-GVCSCD-VB	Vintage Brass
GD-GVCSCD-LB	^ Lifetime Brass

INTERIOR OPTIONS

**Please Specify Function When Ordering:
PA = Passage SD = Single Dummy
PR = Privacy DD = Double Dummy*

PART #	FINISH
GD-GVCGVC* Grande Victorian Knob	Satin Nickel
	Timeless Bronze
	Antique Pewter
	Vintage Brass
	Polished Brass
GD-GVCVER* Versailles Knob	^ Lifetime Brass
	Satin Nickel
	Timeless Bronze
	Antique Pewter
	Vintage Brass
GD-GVCBEL* Bellagio Lever	Polished Brass
	^ Lifetime Brass
	Satin Nickel
	Timeless Bronze
	Antique Pewter

GRANDE VICTORIAN KNOB



BELLAGIO LEVER



SPECIFY LEFT OR RIGHT HAND

INTERIOR GRANDE VICTORIAN KNOB



INTERIOR VERSAILLES KNOB



INTERIOR BELLAGIO LEVER



SPECIFY LEFT OR RIGHT HAND

EXTERIOR S-GRIP



PART #	FINISH
GD-GVCSGR-GVC* Grande Victorian Knob	Satin Nickel
	Timeless Bronze
	Antique Pewter
	Vintage Brass
GD-GVCSGR-VER* Versailles Knob	^ Lifetime Brass
	Satin Nickel
	Timeless Bronze
	Antique Pewter
GD-GVCSGR-BEL* Bellagio Lever	Vintage Brass
	^ Lifetime Brass
	Satin Nickel
	Timeless Bronze

(All exterior sets come with matching single cylinder deadbolt)

*^ Lifetime Brass finish is applied to exterior parts only. Interior product will have normal brass plating.
Supplied with 2-3/8" backset to fit 1-3/8" to 1-3/4" thick doors.
2-3/4" backset is available – Please inquire.*

THE GEORGETOWN COLLECTION



SINGLE CYLINDER DEADBOLTS



SATIN NICKEL = SB



TIMELESS BRONZE = TB



ANTIQUPEWTER = AP



VINTAGE BRASS = VB



LIFETIME BRASS = LB

PART #	FINISH
GD-GEOSCD-SN	Satin Nickel
GD-GEOSCD-TB	Timeless Bronze
GD-GEOSCD-AP	Antique Pewter
GD-GEOSCD-VB	Vintage Brass
GD-GEOSCD-LB	^ Lifetime Brass

INTERIOR OPTIONS

PART #	FINISH
GD-GEOWIN- Windsor Knob	Satin Nickel
	Timeless Bronze
	Antique Pewter
	Vintage Brass
	Polished Brass
GD-GEOVER- Versailles Knob	^ Lifetime Brass
	Satin Nickel
	Timeless Bronze
	Antique Pewter
	Vintage Brass
	Polished Brass
	^ Lifetime Brass

INTERIOR WINDSOR KNOB



INTERIOR VERSAILLES KNOB



**Please Specify Function When Ordering:
PA = Passage SD = Single Dummy
PR = Privacy DD = Double Dummy*

THE NEWPORT COLLECTION

SINGLE CYLINDER DEADBOLTS



SATIN NICKEL = SB



TIMELESS BRONZE = TB



ANTIQUPEWTER = AP



VINTAGE BRASS = VB



LIFETIME BRASS = LB
(EXTERIOR FINISH)

PART #	FINISH
GD-NEWSCD-SN	Satin Nickel
GD-NEWSCD-TB	Timeless Bronze
GD-NEWSCD-AP	Antique Pewter
GD-NEWSCD-VB	Vintage Brass
GD-NEWSCD-LB	^ Lifetime Brass

INTERIOR OPTIONS

PART #	FINISH
GD-NEWBEL- Bellagio Lever	Satin Nickel
	Timeless Bronze
	Antique Pewter
	Vintage Brass
	Polished Brass
GD-NEWVER- Versailles Knob	^ Lifetime Brass
	Satin Nickel
	Timeless Bronze
	Antique Pewter
	Vintage Brass
GD-NEWPRT- Portofino Lever	Polished Brass
	^ Lifetime Brass
	Satin Nickel
	Timeless Bronze
	Antique Pewter
GD-NEWGVC- Grande Victorian Knob	Vintage Brass
	Polished Brass
	^ Lifetime Brass

INTERIOR GRANDE VICTORIAN KNOB



INTERIOR VERSAILLES KNOB



INTERIOR PORTOFINO LEVER



SPECIFY LEFT OR RIGHT HAND

INTERIOR BELLAGIO LEVER



SPECIFY LEFT OR RIGHT HAND

**Please Specify Function When Ordering:
PA = Passage SD = Single Dummy
PR = Privacy DD = Double Dummy*

^ Lifetime Brass finish is applied to exterior parts only. Interior product will have normal brass plating.
Supplied with 2-3/8" backset to fit 1-3/8" to 1-3/4" thick doors.
2-3/4" backset is available - Please inquire.

THE PARTHENON COLLECTION



SINGLE CYLINDER DEADBOLTS



SATIN NICKEL = SN
INTERIOR FINISH



TIMELESS BRONZE = TB



ANTIQUE PEWTER = AP



VINTAGE BRASS = VB



LIFETIME BRASS = LB

PART #	FINISH
GD-PARSCD-SN	Satin Nickel
GD-PARSCD-TB	Timeless Bronze
GD-PARSCD-AP	Antique Pewter
GD-PARSCD-VB	Vintage Brass
GD-PARSCD-LB	^ Lifetime Brass

INTERIOR OPTIONS

**Please Specify Function When Ordering:*

PA = Passage SD = Single Dummy

PR = Privacy DD = Double Dummy

PART #	FINISH
GD-PARCHM-* Chambord Knob	Satin Nickel
	Timeless Bronze
	Antique Pewter
	Vintage Brass
	Polished Brass
^ Lifetime Brass	
GD-PARPAR-* Parthenon Knob	Satin Nickel
	Timeless Bronze
	Antique Pewter
	Vintage Brass
	Polished Brass
^ Lifetime Brass	
GD-PARBEL-* Bellagio Lever	Satin Nickel
	Timeless Bronze
	Antique Pewter
	Vintage Brass
	Polished Brass
^ Lifetime Brass	

CHAMBORD KNOB



PARTHENON KNOB



BELLAGIO LEVER



SPECIFY LEFT OR RIGHT HAND

EXTERIOR HANDLE SETS WITH INTERIOR TRIM



INTERIOR CHAMBORD KNOB



EXTERIOR F-GRIP



INTERIOR PARTHENON KNOB



INTERIOR BELLAGIO LEVER



SPECIFY LEFT OR RIGHT HAND

PART #	FINISH
GD-PARFGR-CHM-* Chambord Knob	Satin Nickel
	Timeless Bronze
	Antique Pewter
	Vintage Brass
^ Lifetime Brass	
GD-PARFGR-BEL-* Bellagio Lever	Satin Nickel
	Timeless Bronze
	Antique Pewter
	Vintage Brass
^ Lifetime Brass	
GD-PARFGR-PAR-* Parthenon Knob	Satin Nickel
	Timeless Bronze
	Antique Pewter
	Vintage Brass
^ Lifetime Brass	

(All exterior sets come with matching single cylinder deadbolt)

^ Lifetime Brass finish is applied to exterior parts only. Interior product will have normal brass plating.
Supplied with 2-3/8" backset to fit 1-3/8" to 1-3/4" thick doors.
2-3/4" backset is available - Please inquire.



The Victorian Collection

Classic Rose Backplate



2.63"
DIA.

PART #	STYLE
NH-CLAVIC*-PR	Privacy
NH-CLAVIC*-PA	Passage

*Add Appropriate Finish Code



7.75"

2.62"

Victorian Knob
Polished Brass

PART #	STYLE
NH-VICVIC*-PR	Privacy
NH-VICVIC*-PA	Passage

*Add Appropriate Finish Code



7.75"

2.62"

Crystal Knob
Polished Brass

PART #	STYLE
NH-VICCRY*-PR	Privacy
NH-VICCRY*-PA	Passage

*Add Appropriate Finish Code

The Meadows Collection

Classic Rose Backplate



2.63"
DIA.

PART #	STYLE
NH-CLAMEA*-PR	Privacy
NH-CLAMEA*-PA	Passage

*Add Appropriate Finish Code

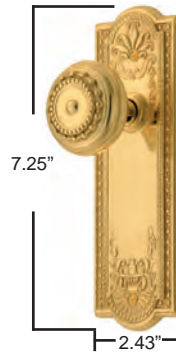

7.25"

2.43"

Meadows Knob
Polished Brass

PART #	STYLE
NH-MEAMEA*-PR	Privacy
NH-MEAMEA*-PA	Passage

*Add Appropriate Finish Code

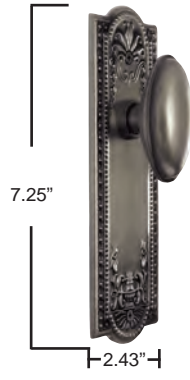

7.25"

2.43"

Homestead Knob
Antique Pewter

PART #	STYLE
NH-MEAHOM*-PR	Privacy
NH-MEAHOM*-PA	Passage

*Add Appropriate Finish Code

The Egg & Dart Collection

Egg & Dart Knob



8.31"

2.37"
Polished Brass

PART #	STYLE
NH-EADEAD*-PR	Privacy
NH-EADEAD*-PA	Passage

*Add Appropriate Finish Code

Waldorf Knob

PART #	STYLE
NH-EADWAL*-PR	Privacy
NH-EADWAL*-PA	Passage

*Add Appropriate Finish Code

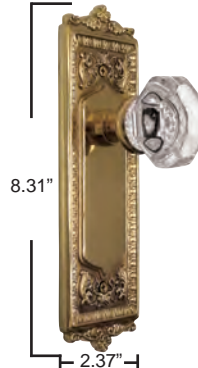

8.31"

2.37"
Antique Brass



2.63"
DIA.

Classic Rose Backplate

PART #	STYLE
NH-CLAEAD*-PR	Privacy
NH-CLAEAD*-PA	Passage

*Add Appropriate Finish Code

Egg & Dart Single Cylinder Deadbolts



POLISHED BRASS *(PB)



ANTIQUPEWTER *(AP)

Meadow Single Cylinder Deadbolts



OIL RUBBED BRONZE *(OB)



ANTIQUPEWTER *(AB)

Victorian Single Cylinder Deadbolts



OIL RUBBED BRONZE *(OB)



ANTIQUPEWTER *(AB)

* FINISHES AVAILABLE

PART #	FINISH
NH-EADSCD-AB	Antique Brass
NH-EADSCD-PB	Polished Brass
NH-EADSCD-AP	Antique Pewter
NH-EADSCD-OB	Old Rubbed Bronze
NH-MEASCD-AB	Antique Brass
NH-MEASCD-PB	Polished Brass
NH-MEASCD-AP	Antique Pewter
NH-MEASCD-OB	Old Rubbed Bronze
NH-VICSCD-AB	Antique Brass
NH-VICSCD-PB	Polished Brass
NH-VICSCD-AP	Antique Pewter
NH-VICSCD-OB	Old Rubbed Bronze

• Mortise Lock sets = MO • Single Dummy = SD • Double Dummy = DD are also available.

RESTORATION DOOR HARDWARE



THE ROSE COLLECTION

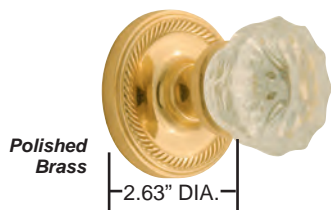

Rope Rose Backplate with Crystal Knob

PART #	STYLE
NH-ROPCRY-*PR	Privacy
NH-ROPCRY-*PA	Passage

**Add Appropriate Finish Code*

Rope Rose Backplate with Waldorf Knob



Antique Pewter

PART #	STYLE
NH-ROPWAL-*PR	Privacy
NH-ROPWAL-*PA	Passage

**Add Appropriate Finish Code*



Classic Rose Backplate with Crystal Knob

PART #	STYLE
NH-CLACRY-*PR	Privacy
NH-CLACRY-*PA	Passage

**Add Appropriate Finish Code*

Classic Rose Backplate with Waldorf Knob



Oil Rubbed Bronze

PART #	STYLE
NH-CLAWAL-*PR	Privacy
NH-CLAWAL-*PA	Passage

**Add Appropriate Finish Code*



Classic Rose Backplate with Homestead Knob

PART #	STYLE
NH-CLAHOM-*PR	Privacy
NH-CLAHOM-*PA	Passage

**Add Appropriate Finish Code*

*** FINISHES AVAILABLE**



POLISHED BRASS *(PB)



ANTIQUE PEWTER *(AP)



BRITE CHROME *(BC)



OIL RUBBED BRONZE *(OB)



ANTIQUE BRASS *(AB)

• Mortise Lock sets = MO • Single Dummy = SD • Double Dummy = DD are also available.

SOLID BRASS TWIST DOORBELLS



Craftsman Style

Twist Plate: 4-3/16" L x 1-1/2" W Bell: 5-5/8" L x 3-7/8" W

Ornate Style

Twist Plate: 3-3/16" L x 1-5/8" W Bell: 4-1/2" L x 3-3/16" W

*** FINISHES AVAILABLE**

BRASS *(BRS)	SATIN NICKEL *(SN)	OIL RUBBED BRONZE *(OB)	ANTIQUE BRASS *(ABR)
--------------	--------------------	-------------------------	----------------------

PART #	STYLE
18054-*	Craftsman
18055-*	Ornate

DOOR HARDWARE

Solid Brass Surface Bolts



Standard Duty
Comes with four 5/8" Phillips flat head wood screws, rim strike & mortise strike.

PART #	SIZE
A 11042*	2"
B 11043*	3"
C 11044*	4"
D 11046*	6"
E 11066*	8"

Heavy Duty

Comes with six 3/4" Phillips oval head wood screws & universal strike.

PART #	SIZE
F 11272*	8"
G 11278*	12"
H 11280*	18"
I 11282*	24"
not shown	11288* 36"



Dutch Door Bolt

4-1/2" Long Rod x 5/8" Diameter
Comes with six 3/4" Phillips oval head wood screws.

PART #
J 11270*

Solid Brass Pocket Door Hardware

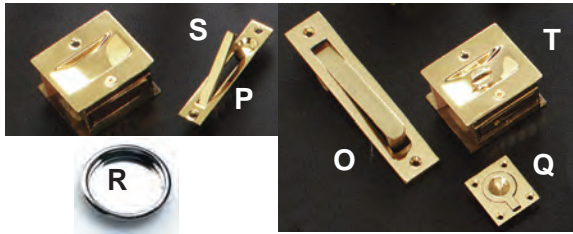

Edge Pulls

6-1/4" comes with two 1" Phillips flat head wood screws
4" comes with two 3/4" Phillips flat head wood screws

PART #	SIZE
O 14010*	6-1/8" x 1-1/4"
P 14020*	3-7/8" x 3/4"

Flush Ring Pull

1-3/4" x 1-1/2"; 2-1/8" Bore. Comes with four 3/4" wood screws

PART #
Q 25220*

Passage Pull

Door Thickness 1-3/8"-1-3/4" - specify. Comes with wood screws.

PART #
S 25410*

Cup Pull

2-1/8" Diameter

PART #
R 25420*

Privacy Pull

Door Thickness 1-3/8"-1-3/4" - specify. Comes with wood screws.

PART #
T 25411*

Solid Brass Storm Door Latch



1-3/4" Backset,
1-7/8" Rose Diameter,
1-7/8" Lever Projection
For Wood Doors 7/8"-1-1/8" Thick
Comes with six 3/4" Phillips oval head wood screws

PART #
21250*

Solid Brass Mortise Door Bolt



1-3/4" Backset, 1/2" Bolt Throw
1/2" Diameter Knob
2-1/2" x 9/16" Case, 1-3/4" x 7/8" Strike

PART #
28500*

Solid Brass Roller Ball Catches



Narrow: 2-1/8" x 1" plate size;
7/16" cylinder,
Strikes 2-1/8" x 1-1/16"
Wide: 2-1/8" x 1" plate size;
7/16" cylinder,
Strikes 2-1/8" x 1-3/8"
Comes with four 1" Phillips flat head wood screws
Available with square or rounded corners

PART #	DESCRIPTION
W 12010*	Narrow - Square
X 12011*	Wide - Square
Y 12012*	Wide - Round
Z 12015*	Narrow - Round

ARCHITECTURAL & DECORATIVE BUILDERS HARDWARE

Steel Hinges: 5/8" Radius Corner Button Tipped - Steel Pin - PLAIN BEARING



Oil Rubbed Bronze Finish



Satin Chrome Finish



Polished Brass Finish



Polished Chrome Finish

PART #	SIZE	FINISH	GAUGE
HN-RCH3-RB	3.5" x 3.5"	Oil Rubbed Bronze US10B	.088"
HN-RCH4-RB	4" x 4"	Oil Rubbed Bronze US10B	.10"
HN-RCH3-SC	3.5" x 3.5"	Satin Chrome US26D	.088"
HN-RCH4-SC	4" x 4"	Satin Chrome US26D	.10"
HN-RCH3-PB	3.5" x 3.5"	Fully Polished Brass US3FP	.088"
HN-RCH4-PB	4" x 4"	Fully Polished Brass US3FP	.10"
HN-RCH3-PC	3.5" x 3.5"	Polished Chrome US26	.088"
HN-RCH4-PC	4" x 4"	Polished Chrome US26	.10"

Steel Hinges: Square Corner Button Tipped - Steel Pin - PLAIN BEARING



Oil Rubbed Bronze Finish



Satin Chrome Finish



Polished Brass Finish



Polished Chrome Finish

PART #	SIZE	FINISH	GAUGE
HN-SCH3-RB	3.5" x 3.5"	Oil Rubbed Bronze US10B	.088"
HN-SCH3-SC	3.5" x 3.5"	Satin Chrome US26D	.088"
HN-SCH4-SC	4" x 4"	Satin Chrome US26D	.10"
HN-SCH3-PB	3.5" x 3.5"	Fully Polished Brass US3FP	.088"
HN-SCH4-PB	4" x 4"	Fully Polished Brass US3FP	.10"
HN-SCH3-PC	3.5" x 3.5"	Polished Chrome US26	.088"
HN-SCH4-PC	4" x 4"	Polished Chrome US26	.10"

Double Action Spring Hinges:



- Allows door to swing back and forth
- For doors up to 1-1/8" thick
- Screws & instructions included
- Dimensions: 4-7/8" high x 3-1/2" wide

PART #	COLOR
DAH-BRS	Brass
DAH-BLK	Black



Steel Hinges - sold in pairs:



Flush - Antique Brass Steel
HINGE-082-AB



Offset - Black Steel
HINGE-084-BLK



Offset - Antique Copper Steel
HINGE-085-AC



Offset - Antique Brass Steel
HINGE-086-AB

DOOR STOPS

Low Profile Solid Brass Door Stop



- High impact vinyl bumper
- 1-3/4" overall dia
- Concealed screw mount installation
- Installation anchor & screw included

DS-7100 (Polished Brass)
DS-7100-SC (Satin Chrome)

High Profile Solid Brass Door Stop



- High impact vinyl bumper
- 1-3/4" overall dia
- Concealed screw mount installation
- Installation anchor & screw included

DS-7101 (Polished Brass)
DS-7101-SC (Satin Chrome)

Heavy Duty Door Floor Stop

- Cast aluminum construction
- 3-5/8" projection with 2-1/8" base plate
- 3 hole surface mount



DS-735AL (Aluminum)
DS-735DB (Dull Brass)

Heavy Duty Door Floor Stop

- Cast aluminum construction
- 3" projection with 2-1/8" base diameter
- Replaceable non-marring rubber bumpers



DS-835AL (Aluminum)
DS-835DB (Dull Brass)

Drop Down Door Holder

- Heavy duty die cast aluminum or solid brass
- Made with 5" drop arm
- Features replaceable rubber tip (*sold separately*)



DS-1095AL (Aluminum)
DS-1095SB (Solid Brass)
RUBBER TIP w/screw
DS-TIP-A

DOOR HARDWARE

Glass Crystal Replacement Knob Set



- 2" diameter fluted glass knobs
- 5/16" square spindle
- Includes spindle and set screws
- Packed 2 knobs per set
- Spindle overall length is 3-7/16"
- Non threaded center is 13/16"

PART #
GDK-2-CL

STAINLESS STEEL HYDRAULIC DOOR CLOSER

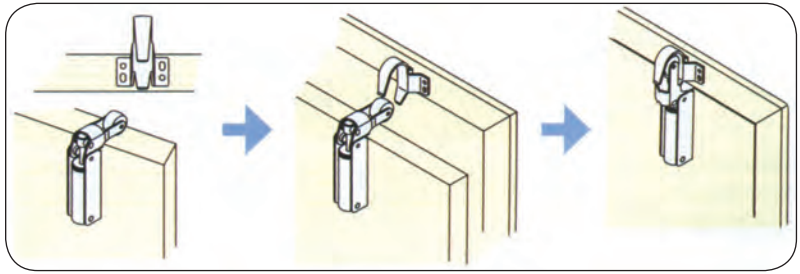

- 304 Stainless steel body with aluminum cylinder and steel pin/shaft.
- Bracket arm catches the roller for self closing at approximately 10°.
- Silent operation, the hydraulic cylinder absorbs shock, preventing the door from slamming shut.
- Easy installation, ideal for retro-fit.
- Works with a maximum door width of 43-5/16".
- Maximum door weight of 176 lbs.

JFR-021205

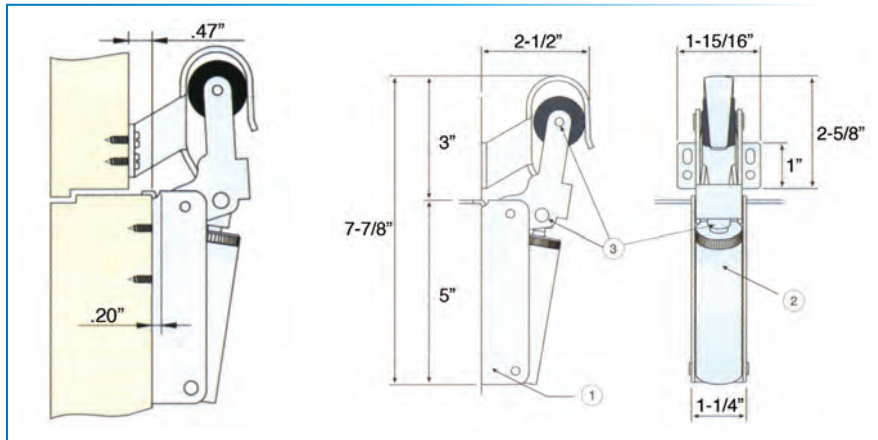
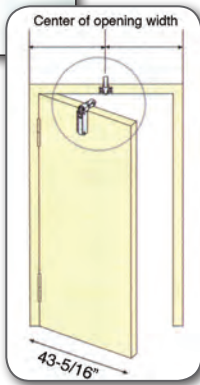

DOOR STOPPER

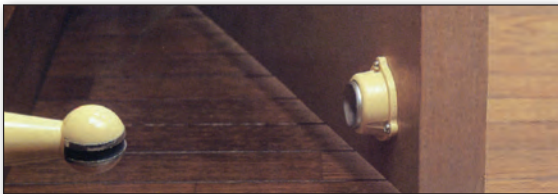

- Strong magnet holds door in the open position.
- 17.6 lbs. of magnetic force per assembly.
- Can be mounted on either the floor or the wall.
- Optional anchor bolt available for installing on concrete surfaces.
- Available in ivory or brown.

PART #
SMDH/IVY
SMDH/BRN
ANCHOR-SMDH^
 ^Optional

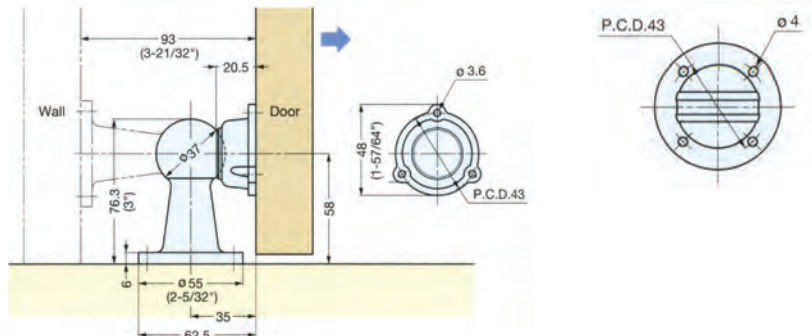

CARPET RODS FOR STAIRWAYS



*Decorate your stairs with style!
For every taste and every budget.*

Brackets



NE BRACKET (1/2")



GR BRACKET (1/2")



SI BRACKET (3/8")

Tubes



REEDED

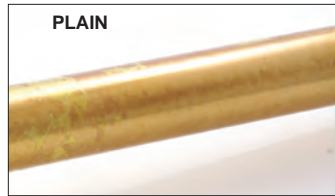

PLAIN

Finials



PINEAPPLE



BALL



URN



ACORN



KNOB

Finishes



POLISHED BRASS



OIL-RUBBED BRONZE



SATIN BRASS

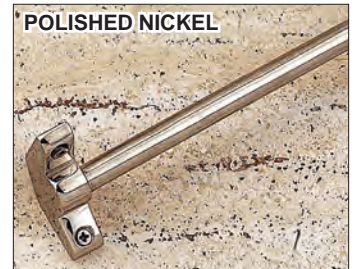

POLISHED NICKEL

PART #	TUBE DIA.	TUBE TYPE	FINIAL TYPE	DESCRIPTION	FINISH
CRS-NE-12REP-3	1/2"	Reeded	Pineapple	36" L, 1/2" Dia, Reeded Tube w/Pineapple Finial - NE Bracket	Polished Brass
CRS-NE-12PLB-3	1/2"	Plain	Ball	36" L, 1/2" Dia, Plain Tube w/Ball Finial - NE Bracket	Oil-Rubbed Bronze
CRS-NE-12REU-3	1/2"	Reeded	Urn	36" L, 1/2" Dia, Reeded Tube w/Urn Finial - NE Bracket	Satin Brass
CRS-NE-12PLA-3	1/2"	Plain	Acorn	36" L, 1/2" Dia, Plain Tube w/Acorn Finial - NE Bracket	Polished Nickel
CRS-GR-12PLA-3	1/2"	Plain	Acorn	36" L, 1/2" Dia, Plain Tube w/Acorn Finial - GR Bracket	Oil-Rubbed Bronze
CRS-GR-12PLK-3	1/2"	Plain	Knob	36" L, 1/2" Dia, Plain Tube w/Knob Finial - GR Bracket	Polished Brass
CRS-GR-12PLB-3	1/2"	Plain	Ball	36" L, 1/2" Dia, Plain Tube w/Ball Finial - GR Bracket	Polished Nickel
CRS-SI-38PLP-3	3/8"	Plain	Pineapple	36" L, 3/8" Dia, Plain Tube w/Pineapple Finial - SI Bracket	Polished Brass
CRS-SI-38PLU-3	3/8"	Plain	Urn	36" L, 3/8" Dia, Plain Tube w/Urn Finial - SI Bracket	Polished Brass
CRS-SI-38PLB-3	3/8"	Plain	Ball	36" L, 3/8" Dia, Plain Tube w/Ball Finial - SI Bracket	Polished Brass

Most popular combinations are shown in the chart above; OTHER COMBINATIONS AVAILABLE, PLEASE INQUIRE.

HOOKS

COAT & HAT HOOKS

Material: Zinc • Matching screws included

- 3" Projection

Finishes Available:
Brite Brass (*BR), Brite Chrome (*BC)



PART #
CH-37*

- Heavy Duty 4-1/2" O.D.
- Projection-
Satin Nickel: 3-9/16"

Finish Available: Satin Nickel



PART #
CH-38-SN

- 2-3/16" Projection

Finishes Available:
Brite Brass (*BR), Brite Chrome (*BC)

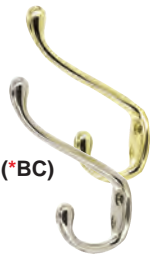

PART #
CH-39*



Material: Stainless Steel • Matching screws included • ROHS Accredited



HOOKS

- 304 Stainless steel
- NSF Approved

Finish Available: Mirror



PART #	LOAD CAPACITY	PROJ.	OVERALL HEIGHT
FC-50	22 lbs.	1-27/32"	1-29/64"
FC-65	26 lbs.	2-9/16"	1-47/64"

- 304 Stainless steel

Finish Available: Satin



PART #	LOAD CAPACITY	PROJ.	OVERALL HEIGHT
HJT-55	22 lbs.	1-19/64"	2.165"
HJT-70	17.6 lbs.	1-21/32"	2.756"

FORK HOOK

- 316 Stainless steel

Finish Available: Mirror



PART #	LOAD CAPACITY	PROJ.	OVERALL HEIGHT
EU-50	44 lbs.	1-1/2"	1-31/32"
EU-72	66 lbs.	2-3/64"	2-53/64"

ROTATING SPECIALTY HOOK

- 304 Stainless steel
- Rotates 360°
- NSF Approved

Finish Available: Satin



PART #	LOAD CAPACITY	PROJ.	OVERALL HEIGHT
RF-50	6.6 lbs.	1-31/32"	1-17/32"

SWING SPECIALTY HOOK

- 304 Stainless steel
- Hook has constant torque when swiveling
- Ideal for vibration or shock applications

Finish Available: Polished

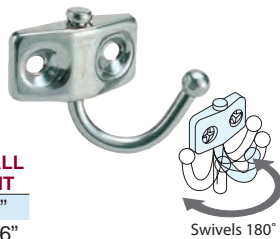

PART #	LOAD CAPACITY	PROJ.	OVERALL HEIGHT
TK-30F	17 lbs.	1-27/64"	1-1/2"
TK-45F	26 lbs.	1-3/4"	1-11/16"

BUTTERFLY SPECIALTY HOOK

- 304 Stainless steel
- Flush or corner mount
- Applicable angle: 90°-270°

Finish Available: Polished



PART #	LOAD CAPACITY	PROJ.	OVERALL HEIGHT
TZ-360	6-13 lbs.	1-41/64"	1-27/64"

LATCH HOOKS

- 316 Stainless steel
- Keeps items hooked
- Ideal for vibration or shock applications

Finish Available: Polished



PART #	LOAD CAPACITY	PROJ.	OVERALL HEIGHT
EN-K84	44 lbs.	1-1/2"	3-5/16"
EN-K120	44 lbs.	2-1/8"	4-23/32"

- 316 Stainless steel
- Keeps items hooked
- Ideal for vibration or shock applications

Finish Available: Polished



PART #	LOAD CAPACITY	PROJ.	OVERALL HEIGHT
EN-R80	44 lbs.	1-1/4"	3-5/32"

HEAT REGISTERS

New

Material: High Strength Polymer Resin

*Available in Almond, Black, Grey, Tan, Taupe, Snow White, Wood Grain & Chocolate Brown

- Great for floor, ceiling or wall applications
- “Finger tip” control
- Filter cloth pins

CLASSIC

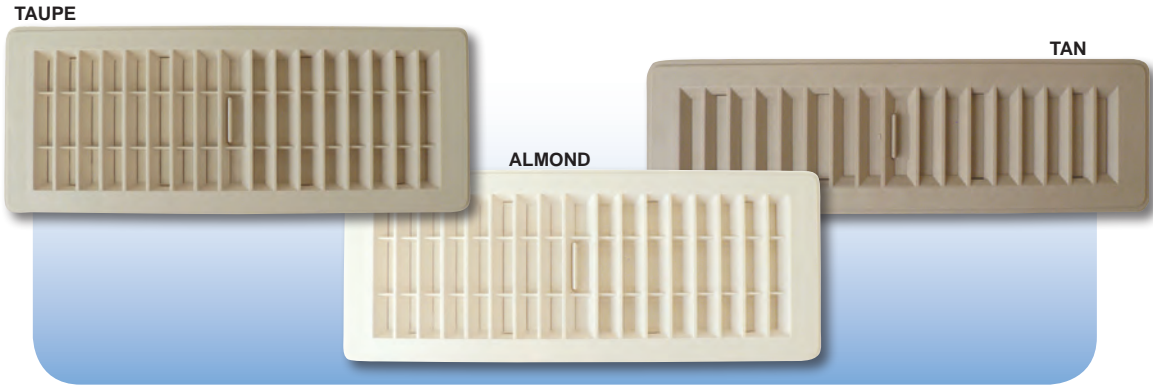

PART #	*COLORS	SIZE	FREE AREA	PCS PER CARTON
HVC-HR410-*	Almond (AL), Black (BK), Grey (GY), Tan (TN), Taupe (TP), Snow White (WH) & Chocolate Brown (CB)	4" x 10"	13.8 Sq. In.	20
HVC-HR410-*	Wood Grain (WG)	4" x 10"	13.8 Sq. In.	20
HVC-HR412-*	Almond (AL), Black (BK), Grey (GY), Tan (TN), Taupe (TP), Snow White (WH) & Chocolate Brown (CB)	4" x 12"	16.9 Sq. In.	25
HVC-HR412-*	Wood Grain (WG)	4" x 12"	16.9 Sq. In.	25

DESIGNER



PART #	*COLORS	SIZE	FREE AREA	PCS PER CARTON
HVC-HR410DG-*	Almond (AL), Black (BK), Grey (GY), Tan (TN), Taupe (TP), Snow White (WH) & Chocolate Brown (CB)	4" x 10"	13.8 Sq. In.	20
HVC-HR410DG-*	Wood Grain (WG)	4" x 10"	13.8 Sq. In.	20

INDOOR RETURN AIR GRILLES

Material: High Strength Polymer Resin

Available in Snow White

New



- Screw holes on each size of vent and an extra in the center for grilles 20" or wider
- Includes white painted screws



FLUSH MOUNT

3/8" depth

PART #	SIZE	FREE AREA	PCS PER CARTON
HVC-RGFLU-66WH	6" x 6"	22.7 Sq. In.	40
HVC-RGFLU-86WH	8" x 6"	30.00 Sq. In.	40
HVC-RGFLU-106WH	10" x 6"	37.7 Sq. In.	40
HVC-RGFLU-126WH	12" x 6"	45.4 Sq. In.	40
HVC-RGFLU-128WH	12" x 8"	60.5 Sq. In.	36
HVC-RGFLU-148WH	14" x 8"	70.2 Sq. In.	36

BASEBOARD MOUNT

3/4" depth

PART #	SIZE	FREE AREA	PCS PER CARTON
HVC-RGBAS-106WH	10" x 6"	37.7 Sq. In.	20
HVC-RGBAS-126WH	12" x 6"	45.4 Sq. In.	20
HVC-RGBAS-146WH	14" x 6"	52.7 Sq. In.	20
HVC-RGBAS-206WH	20" x 6"	75.3 Sq. In.	20
HVC-RGBAS-246WH	24" x 6"	90.8 Sq. In.	10
HVC-RGBAS-306WH	30" x 6"	113.5 Sq. In.	10
HVC-RGBAS-128WH	12" x 8"	60.5 Sq. In.	20
HVC-RGBAS-148WH	14" x 8"	70.2 Sq. In.	20
HVC-RGBAS-248WH	24" x 8"	121.00 Sq. In.	10
HVC-RGBAS-308WH	30" x 8"	151.2 Sq. In.	10

SHUTTER HARDWARE

A. SHUTTER DOGS are functional, metal ornaments used to hold your shutters open against the face of your house

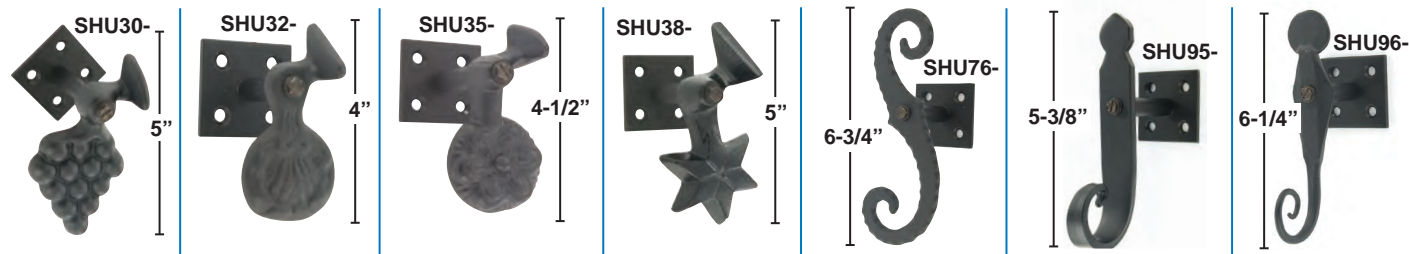

PART #	DESCRIPTION	SHIPPING WEIGHT PER PR.
SHU30-L	Grape	2 lbs.
SHU30-P	Grape	2-1/2 lbs.
SHU30-LA	Grape	4 lbs.
SHU32-L	Shell	1 lb.
SHU32-P	Shell	1-1/2 lbs.
SHU32-LA	Shell	2-3/4 lbs.
SHU35-L	Flower	1-1/2 lbs.
SHU35-P	Flower	1-3/4 lbs.
SHU35-LA	Flower	3 lbs.
SHU38-L	Star	1-1/2 lbs.
SHU38-P	Star	1-3/4 lbs.
SHU38-LA	Star	3 lbs.
SHU76-L	"S"	1 lb.
SHU76-P	"S"	1-1/2 lbs.
SHU76-LA	"S"	2-3/4 lbs.
SHU95-L	Rat Tail	1-1/4 lbs.
SHU95-P	Rat Tail	1-3/4 lbs.
SHU95-LA	Rat Tail	3 lbs.
SHU96-L	Old Phila Style	1-1/4 lbs.
SHU96-P	Old Phila Style	1-1/2 lbs.
SHU96-LA	Old Phila Style	2-3/4 lbs.

NOTE: Plate = 2" x 2", Sill mount is 15-3/4" wide.

B. HEAVY DUTY L-TYPE SHUTTER HINGES

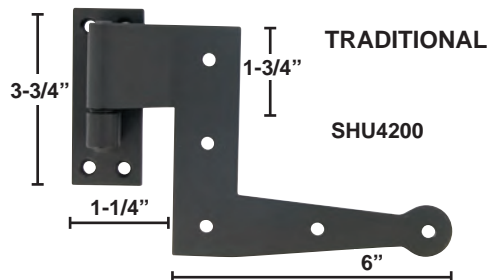
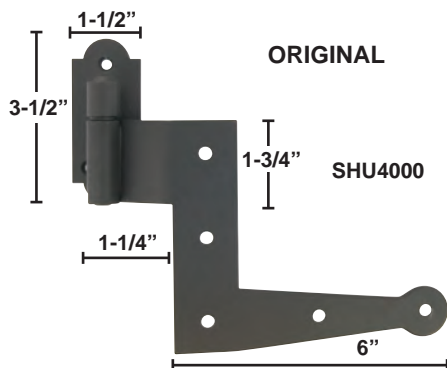

PART #	DESCRIPTION	OFFSET	PINTLE PLATE	PINTLE DIA.	SHIPPING WEIGHT
SHU4000A	Original	1/2"	1/8" Thick	3/8" Thick	1 lb. 8 oz.
SHU4000B	Original	1-1/2"	1/8" Thick	3/8" Thick	1 lb. 12 oz.
SHU4000C	Original	2-1/4"	1/8" Thick	3/8" Thick	2 lbs.
SHU4200A	Traditional	1/2"	1/8" Thick	3/8" Thick	1 lb. 1 oz.
SHU4200B	Traditional	1-1/2"	1/8" Thick	3/8" Thick	1 lb. 14 oz.
SHU4200C	Traditional	2-1/4"	1/8" Thick	3/8" Thick	2 lb. 2 oz.

LONG ARM EXTENSION
The long arm extension also known as a sill mount, is used with **stone construction**. The long arm extension mounts to the window sill and projects the shutter dog out so that is in front of your shutter.

SURFACE PLATE
The surface plate is used with **frame construction** only. This plate comes with screws for mounting directly to wood siding.

LAG BOLT
The lag bolt can be used to mount shutter dogs to buildings with **stone, stucco, brick or frame construction**

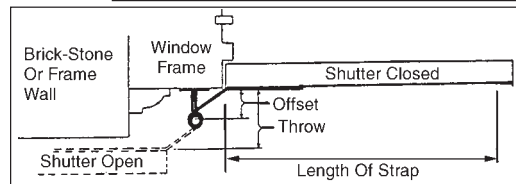
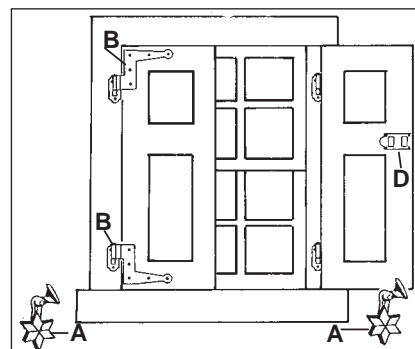

C. SHUTTER RINGS

PART #	DESCRIPTION	SHIPPING WEIGHT
SHU750	Shutter Ring Pull	1 oz.
SHU770	Shutter Ring Pull	4 oz.

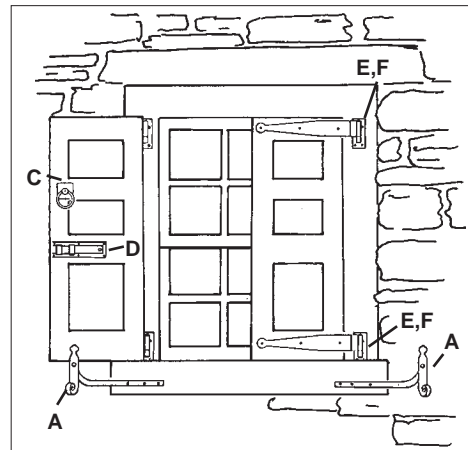
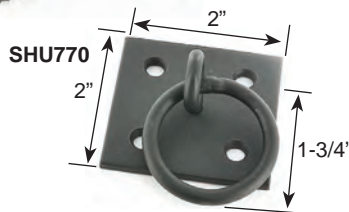

D. SHUTTER BOLTS

PART #	DESCRIPTION	SHIPPING WEIGHT
SHU607	Original	1 lb. 2 oz.

Overall Size 12" x 2", Strike 4-1/8" x 2", Bolt Plate 7-7/8" x 2", Bolt 6-7/8" x 1" x 1/4", Plate Gauge #14, Projection 13/16"

PART #	DESCRIPTION	SHIPPING WEIGHT
SHU707	Traditional	1 lb. 1 oz.

Overall Size 10-3/4" x 2", Strike 3-1/2" x 2", Bolt Plate 7-1/4" x 2", Bolt 6-7/8" x 1" x 1/4", Plate Gauge #14, Projection 13/16"



Shutters in closed position

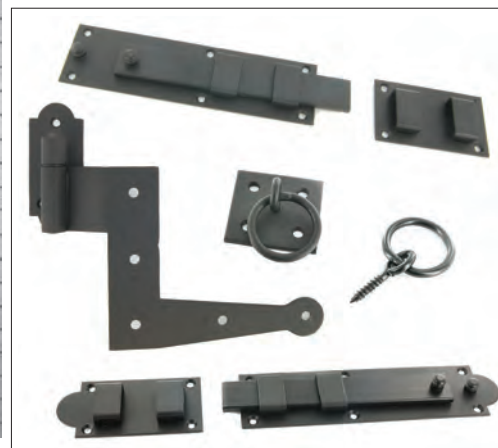

E. SHUTTER HINGE PARTS - HINGES -

ONLY FOR 3/8" PIN DIA.

PART #	LENGTH	OFFSET	SHIPPING WEIGHT
SHU1110A	10"	1/2"	1 lb.
SHU1110B	10"	1-1/2"	1 lb. 1 oz.
SHU1110C	10"	2-1/4"	1 lb. 3 oz.
SHU1110D	10"	3-1/4"	1 lb. 4 oz.
SHU1112A	12"	1/2"	1 lb. 4 oz.
SHU1112B	12"	1-1/2"	1 lb. 5 oz.
SHU1112C	12"	2-1/4"	1 lb. 6 oz.
SHU1112D	12"	3-1/4"	1 lb. 8 oz.
SHU1114A	14"	1/2"	1 lb. 7 oz.
SHU1114B	14"	1-1/2"	1 lb. 8 oz.
SHU1114C	14"	2-1/4"	1 lb. 9 oz.
SHU1114D	14"	3-1/4"	1 lb. 10 oz.
SHU1116A	16"	1/2"	1 lb. 8 oz.
SHU1116B	16"	1-1/2"	1 lb. 10 oz.
SHU1116C	16"	2-1/4"	1 lb. 12 oz.
SHU1116D	16"	3-1/4"	1 lb. 14 oz.



HINGES ARE SOLD PER PAIR, PINTLES SOLD SEPARATELY

F. SHUTTER HINGE PARTS - PINTLES

3/8" PIN DIA.

PART #	OFFSET	SPECS	SHIPPING WEIGHT
SHU1000-2A	1/2"	Pin Dia. 3/8",	10 oz.
SHU1000-2B	1-1/2"	Pin Height 1-7/8"	11 oz.
SHU1000-2C	2-1/4"	Plate Size	13 oz.
SHU1000-2D	3-1/4"	1-1/2" x 3-1/2"	15 oz.
SHU2000-2A	1/2"	Pin Dia. 3/8",	12 oz.
SHU2000-2B	1-1/2"	Pin Height 1-7/8"	13 oz.
SHU2000-2C	2-1/4"	Plate Size	15 oz.
SHU2000-2D	3-1/4"	1-1/2" x 3-3/4"	17 oz.
SHU2000-3	-	Pin Dia. 3/8", Pin Height 1-7/8" O.A. Length of Screw 4"	7 oz.



SHU1000-2 ORIGINAL



SHU2000-2 TRADITIONAL



SHU2000-3 SCREW

TOILET PARTITION HARDWARE

- All inclusive kits include everything needed for complete stall installation
- Available for either 7/8" or 1" thick doors
- Available for either inswing or outswing doors
- Fits 1-1/4" thick posts

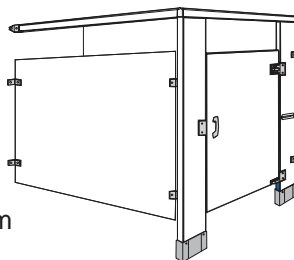

COMPLETE STALL KITS

Includes: 2 ear panel pack, 1 ear pilaster pack, top & bottom hinge assemblies, pilaster shoe pack and either inswing or outswing door pack. **(DOOR NOT INCLUDED)**

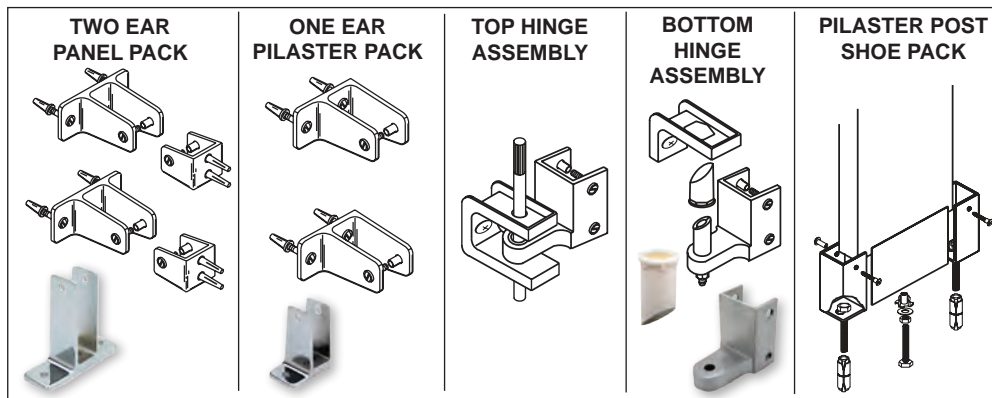

PART #	DESCRIPTION
CSK-1100	Inswing kit for 7/8" door
CSK-1200	Inswing kit for 1" door
CSK-2100	Outswing kit for 7/8" door
CSK-2200	Outswing kit for 1" door

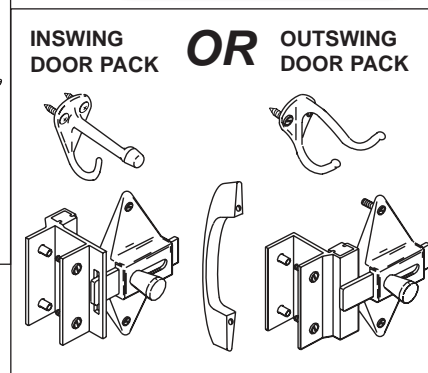

ADDITIONAL STALL KITS

Includes: 2 ear panel pack, top & bottom hinge assemblies, pilaster shoe pack and either inswing or outswing door pack. **(DOOR NOT INCLUDED)**

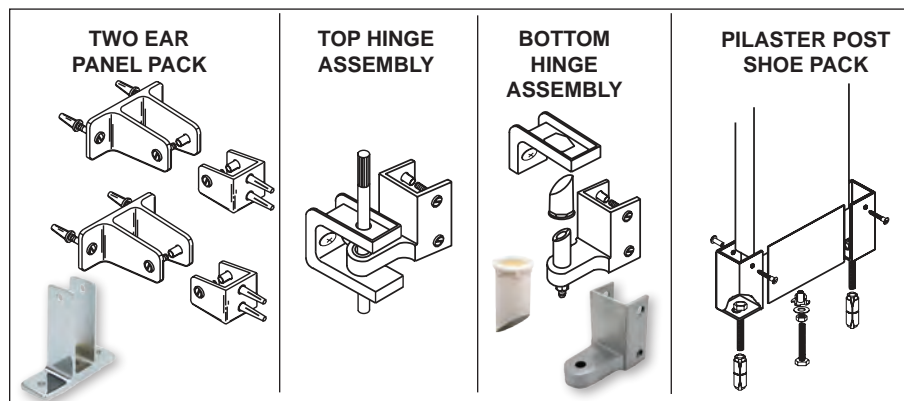

PART #	DESCRIPTION
ASK-1110	Inswing kit for 7/8" door
ASK-1210	Inswing kit for 1" door
ASK-2110	Outswing kit for 7/8" door
ASK-2210	Outswing kit for 1" door

